

Encoder WDG 58B



- Rugged industrial standard encoder
- Up to 25000 PPR by use of high grad electronics
- Protection to IP67, shaft sealed to IP65
- Maximum mechanical and electrical safety
- Full connection protection with 10 VDC up to 30 VDC
- With light reserve warning
- Optional: -40 °C up to +80 °C
Protection to IP67 all around

www.wachendorff-automation.com/wdg58b

Available PPR up to 25000 PPR

Mechanical Data

Housing

- Clamping flange: Aluminium
- Cap: Aluminium, powder coated
- Cam mounting: pitch 69 mm

Shaft

- Ø 10 mm
- Material: stainless steel
- Permitted load on shaft end: max. 220 N radial
max. 120 N axial
- Starting torque: approx. 1 Ncm at ambient temperature

Bearings

- Type: 2 precision ball bearings
- Service life: 1 x 10⁹ revs. at 100 % rated shaft load
1 x 10¹⁰ revs. at 40 % rated shaft load
1 x 10¹¹ revs. at 20 % rated shaft load

Max. operating speed: 8000 rpm

Weight: approx. 250 g

Connections: cable or connector

Protection rating: IP67, shaft sealed to IP65
(EN 60529)

Operating temperature: -20 °C up to +80 °C, 1 Vss: -10 °C up to +70 °C

Storage temperature: -30 °C up to +80 °C

Machinery Directive: basic data safety integrity level

- MTTF_d: 200 a
- Mission time (T_M): 25 a
- Nominale service life (L_{10h}): 1 x 10¹¹ revs. at 8000 rpm and 20 % rated shaft load
- Diagnostic coverage (DC): 0 %

Electrical Data

- Power supply/ Open circuit current consumption: 4.75 VDC up to 5.5 VDC: max. 100 mA
5 VDC up to 30 VDC: max. 70 mA
10 VDC up to 30 VDC: max. 100 mA

Output circuit: TTL, RS422 compatible
HTL
1 Vss Sin/Cos

- Pulse frequency: TTL ≤ 5000 PPR: max. 200 kHz
HTL ≤ 5000 PPR: max. 200 kHz
TTL > 5000 PPR: max. 2 MHz
HTL > 5000 PPR: max. 600 kHz
1 Vss Sin/Cos: max. 100 kHz

Channels: AB, ABN and inverted signals

Load: max. 40 mA/channel,
@ 1 Vss Sin/Cos: 120 Ohm termination

Circuit protection: circuit type F24, G24, H24, I24, P24, R24 only

Accuracy: Phase offset: 90° ± max. 7.5 %
of the pulse length
pulse-/pause-ratio: 50 % ± max. 7 %

Further technical information on:

www.wachendorff-automation.com/gtd

Matching accessories on: www.wachendorff-automation.com/acs

Cable connection K2, K3, L2, L3 with 2 m cable

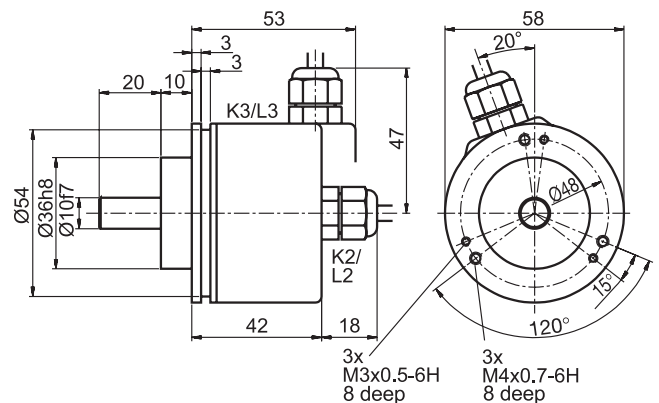

Connector (M16x0.75) SI, SH, 5-, 6-, 8-, 12-pin and S2, S3, 7-pin

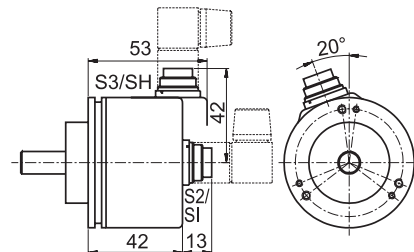

Connector (M23) S4, S5, S4R, S5R, 12-pin

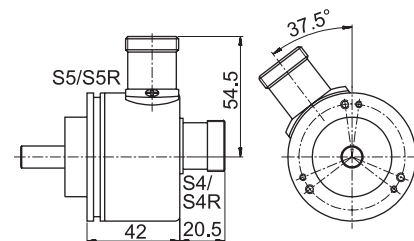

MIL-connector S6, 6-pin

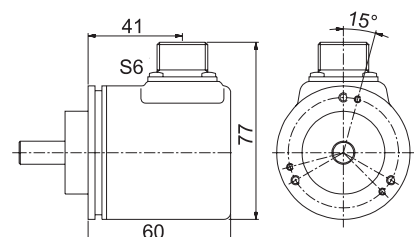

Valve-connector S7, 4-pin

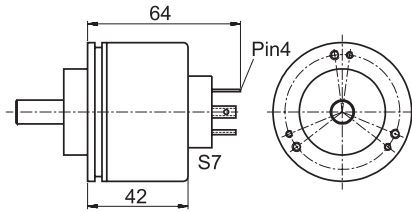

Sensor-connector (M12x1) SB, SC, 4-, 5-, 8-, 12-pin

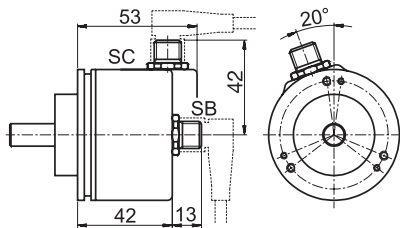

All dimensional specifications in mm.

Options:

Low-temperature:

The encoder WDG 58B with the output circuit types F24, G24, H24, I24, P24, R24, F05, G05, H05, I05, P05, R05, 245, 524 and 645 is also available with the extended temperature range -40 °C up to +80 °C (measured at the flange). When ordering please add the suffix code - ACA.

Shaft with flat:

The encoder WDG 58B can be supplied with a shaft with flat. When ordering please add the suffix code - AAF.

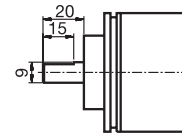

Drawing 58B-AAF

Low-friction bearings:

The encoder WDG 58B is also available as a particularly smooth-running low-friction encoder. The starting torque is thereby changed to ≤ 0.1 Ncm and the protection class at the shaft input to IP50. When ordering please add the suffix code - AAC.

Shafts sealed to IP67 (not for 1 Vss Sin/Cos):

The encoder WDG 58B can be supplied in a full IP67 version. When ordering please add the suffix code - AAO.

Max. RPM	Permitted Shaft-Loading axial	Max. PPR	Starting-torque
3500 rpm	100 N	110 N	2500 PPR
			approx. 4 Ncm

Amended specifications for shaft sealed to IP67.

Cable length:

The encoder WDG 58B can be supplied with more than 2 m cable. The maximum cable length depends on the supply voltage and the frequency; see „General Technical Data“:

www.wachendorff-automation.com/gtd

Please extend the standard order code with a three figure number, specifying the cable length in decimetres.

Example: 3 m cable = 030

Ordering information:

Please see our general technical data at: www.wachendorff-automation.com/gtd

Output circuit:				
Resolution PPR	Power supply VDC	Output circuit	Light reserve warning	Order Key
up to 2500	5 - 30	HTL	-	H30
		HTL inverted	-	R30
up to 5000	4,75 - 5,5	TTL	•	G05
		TTL, RS422 comp., inverted	•	H05
		TTL	•	I05
		TTL, RS422 comp., inverted	-	R05
	10 - 30	HTL	•	G24
		HTL inverted	•	H24
		HTL inverted	•	I24
		TTL, RS422 comp., inverted	-	R24
10000 up to 25000	4,75 - 5,5	TTL	-	F05
		TTL, RS422 comp., inv.	-	P05
	10 - 30	HTL	-	F24
		HTL invertiert	-	P24
		TTL, RS422 comp., inv.	-	645
1024 2048	4,75 - 5,5	1 Vss Sin/Cos	-	SIN

Channels: AB, ABN (SIN: AB)

Pulses per revolution PPR:
 2, 5, 10, 15, 20, 24, 25, 30, 36, 40, 48, 50, 60, 64, 72, 87, 90, 100, 120, 125, 127, 128, 150, 160, 180, 200, 216, 240, 250, 254, 256, 300, 314, 320, 360, 400, 500, 512, 571, 600, 625, 720, 750, 768, 800, 810, 900, 1000, 1024, 1200, 1250, 1270, 1440, 1500, 1800, 2000, 2048, 2400, 2500, 3000, 3600, 4000, 4096, 4685, 5000, 10000, 12500, 20000, 25000.
 1 Vss Sin/Cos 1024 PPR and 2048 PPR only
 Other PPRs on request

Electrical connections:			
Order key	Outgoing	Description	ABN inv.
Cable: (Length 2 m standard)			
K2	axial	shield not connected	•
L2		shield connected to encoder housing	•
K3	radial	shield not connected	•
L3		shield connected to encoder housing	•
Connector:			
SI5	axial	5-pin, connector	-
SH5	radial		-
SI6	axial	6-pin, connector	-
SH6	radial		-
SI8	axial	8-pin, connector	•
SH8	radial		•
SI12	axial	12-pin, connector	•
SH12	radial		•
S2	axial	7-pin, connector	-
S3	radial		-
S4/S4R	axial	12-pin, connector	•
S5/S5R	radial	(R = clockwise pin count)	•
S6	radial	6-pin, MIL-connector	-
S7	axial	4-pin, Valve-connector	-
SB4	axial	4-pin, M12-sensor-connector	-
SC4	radial		-
SB5	axial	5-pin, M12-sensor-connector	-
SC5	radial		-
SB8	axial	8-pin, M12-sensor-connector	•
SC8	radial		•
SB12	axial	12-pin, M12-sensor-connector	•
SC12	radial		•

Options:	
Empty	= Without option
ACA	= Low-temperature -40 °C up to +80 °C
AAF	= Shaft with flat
AAC	= Low-friction bearings
AAO	= Shaft sealed to IP67
In decimetres	= Cable length

Order No.:

Example	WDG 58B	5000	ABN	G24	K2	
Your encoder	WDG 58B					